

18
10
81
90

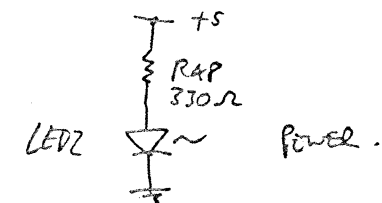

ITEM	DESCRIPTION	REQ'D	MATERIAL	REMARKS
	PROCESSOR, EPROMS, TIMING, ADDRESS DECODE & INTERRUPTS.		SCALE	PASSED
				DATE
			DRAWN	DRAWING NUMBER
			TRACED	1
			CHECKED	

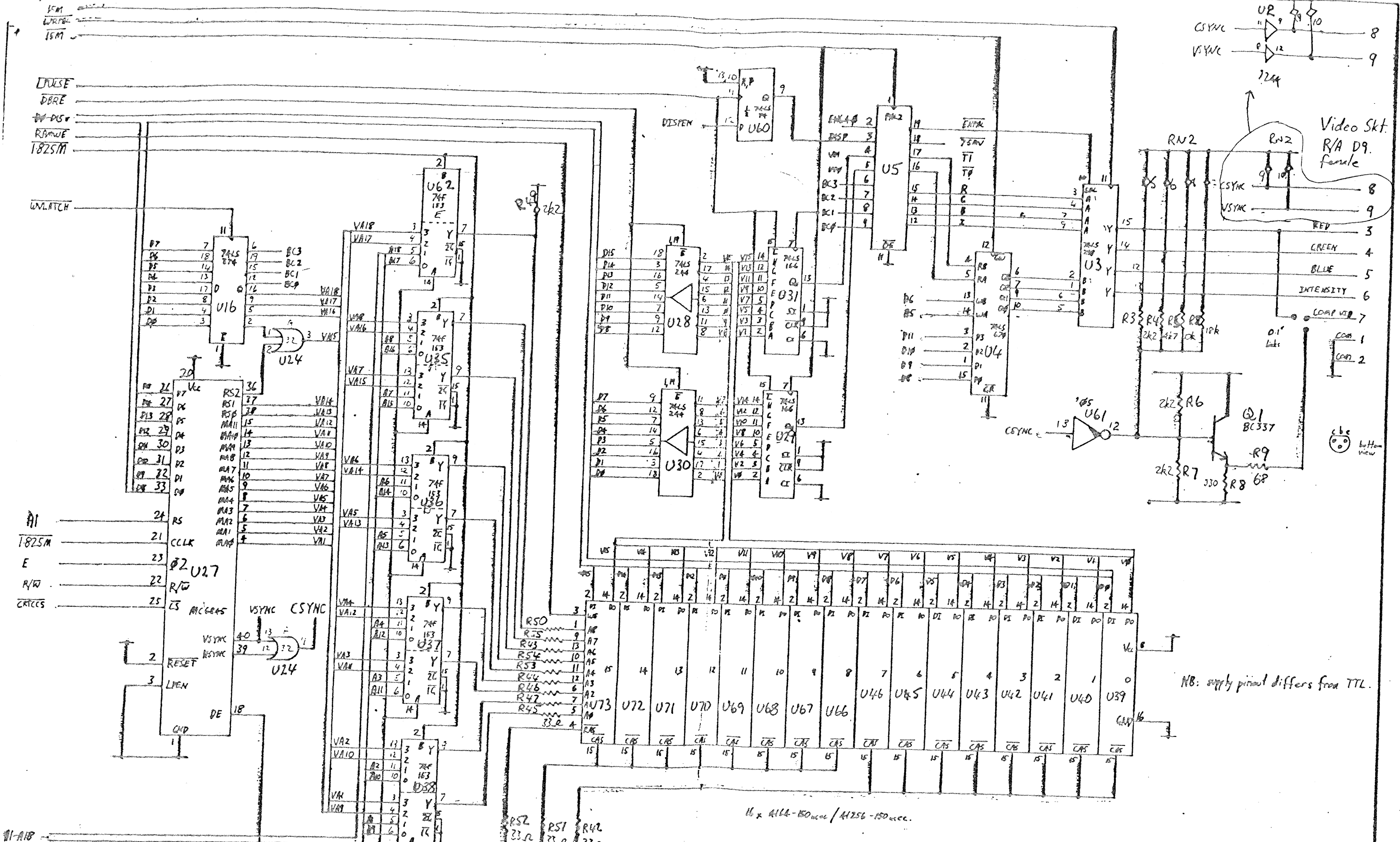

NB: supply pinout differs from TTL.

16 x 1K14-150uSec / 1K256-150uSec.

DISPEN

ITEM	DESCRIPTION	REQ'D	MATERIAL	REMARKS
	V _{VIDEO} , RAM control.		SCALE	PASSED
				DATE
		DRAWN		DRAWING NUMBER
		TRACED		2
		CHECKED		

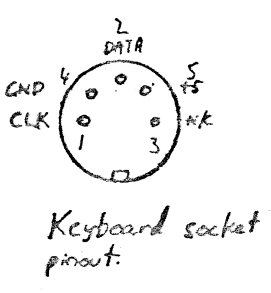
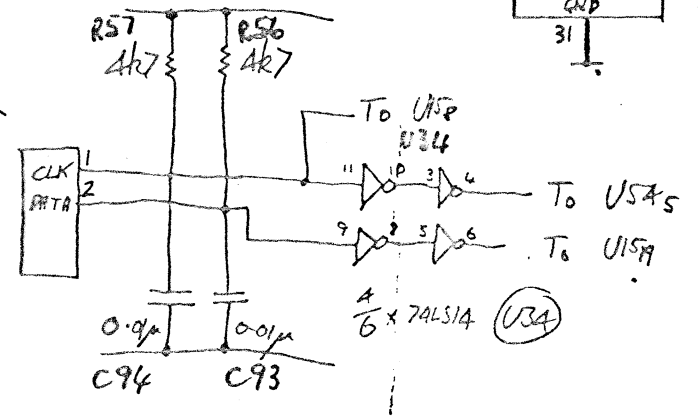
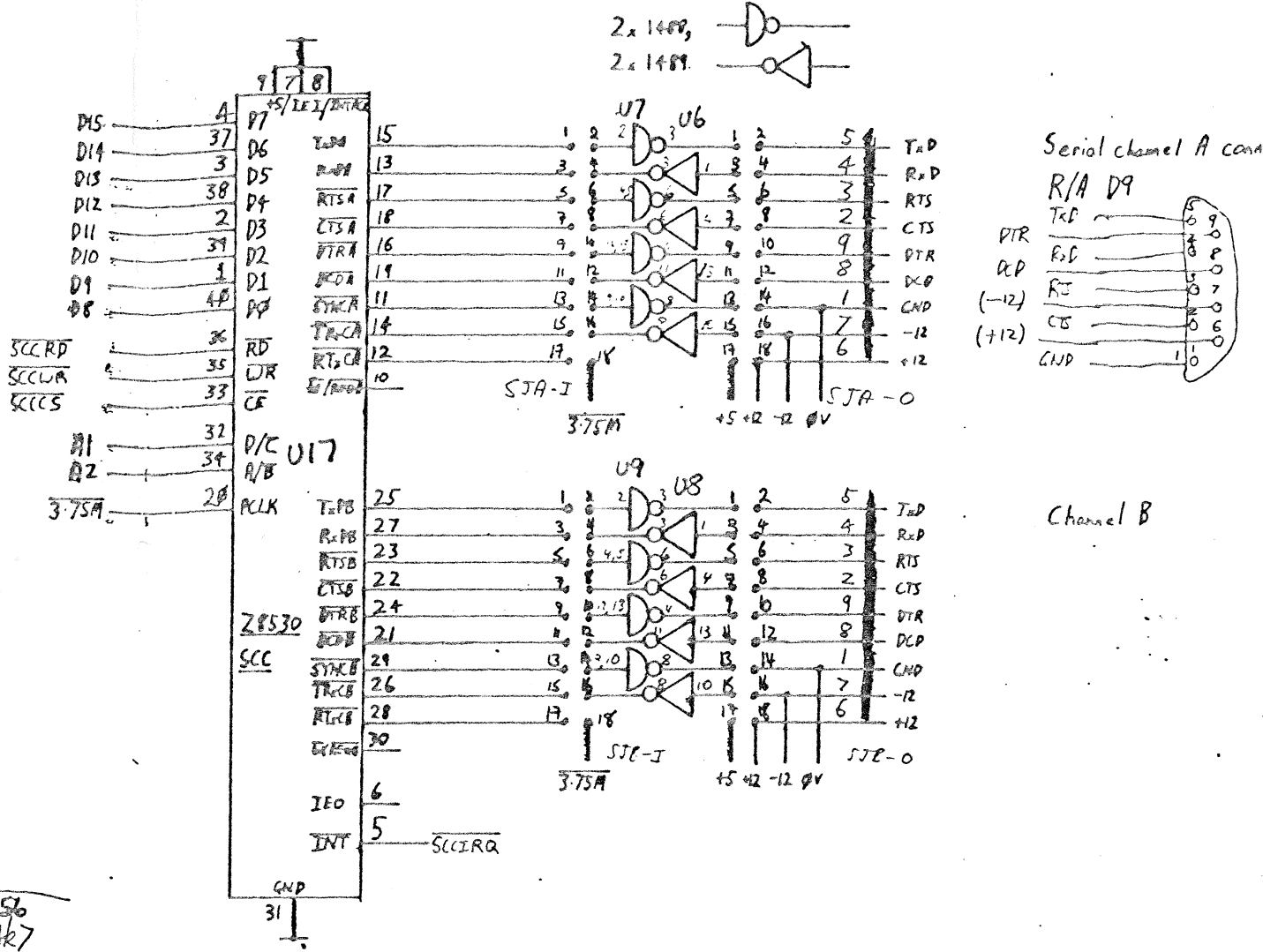
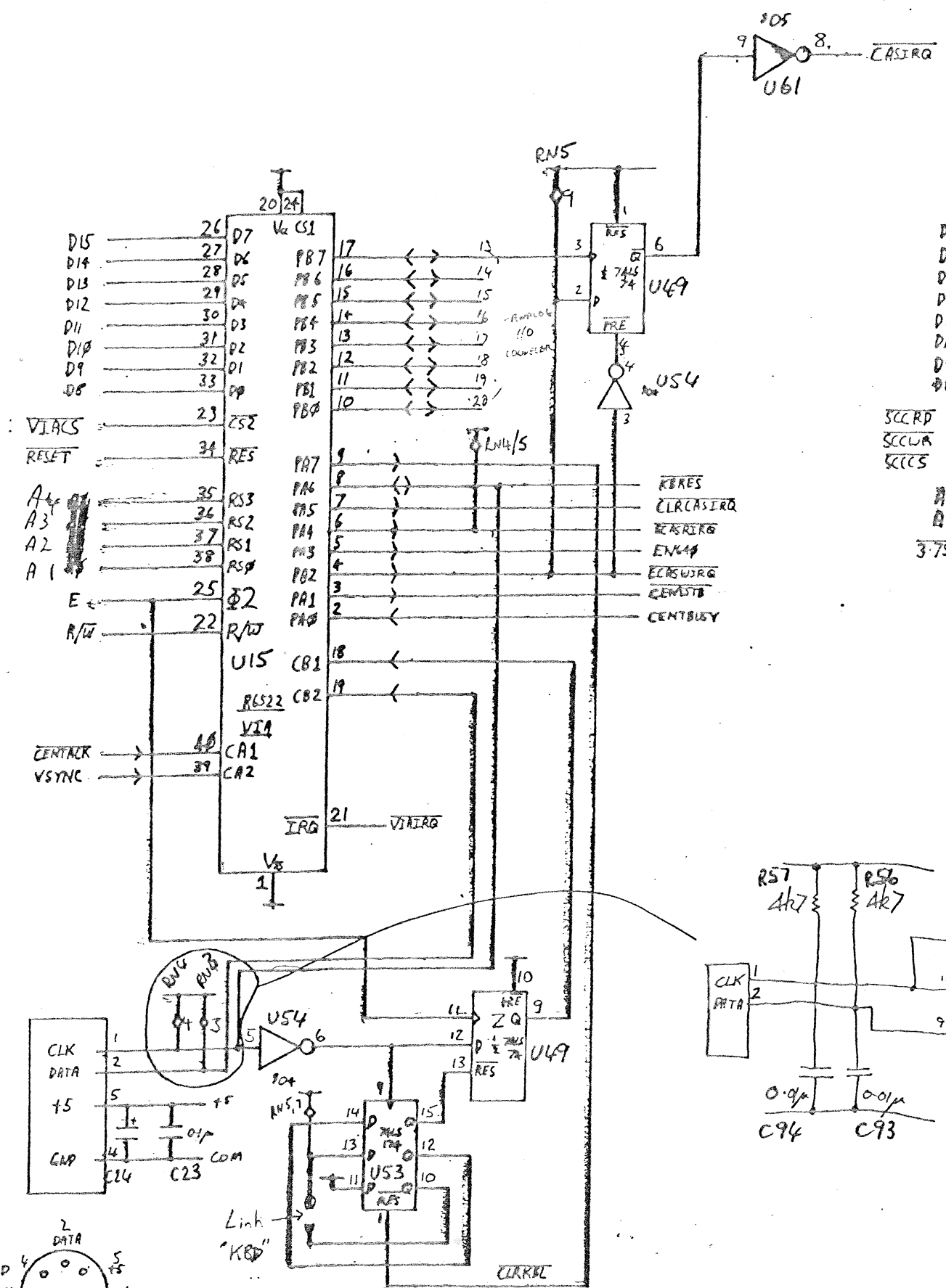

ITEM	DESCRIPTION	REQ'D	MATERIAL	REMARKS
	VIA, Keyboard interface, timer/interrupts & Serial I/O.		SCALE	PASSED DATE
		DRAWN		DRAWING NUMBER
		TRACED		3
		CHECKED		

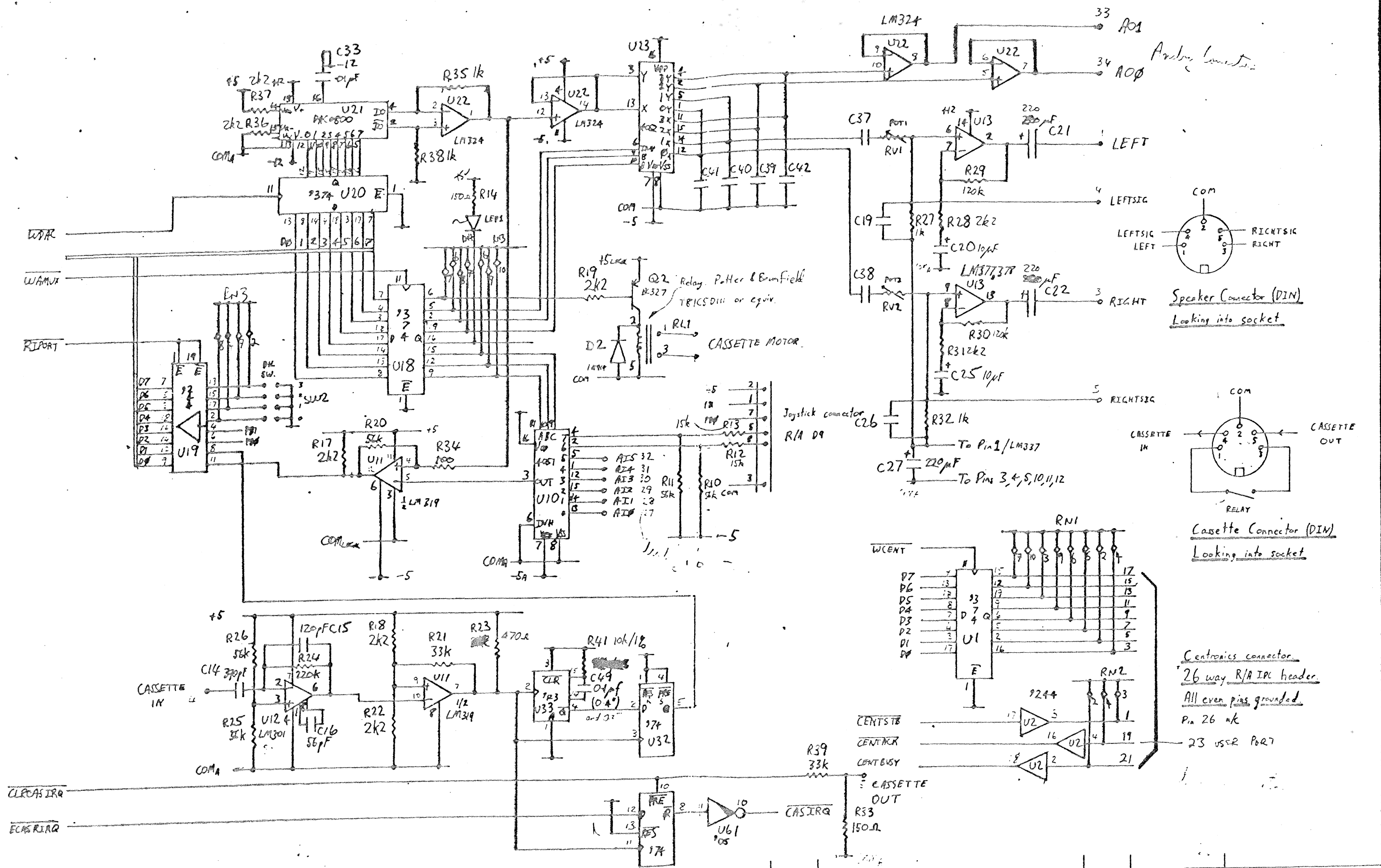

Analog Outputs

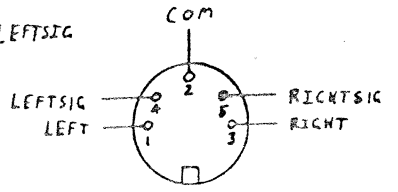

Speaker Connector (DIN)
Looking into socket

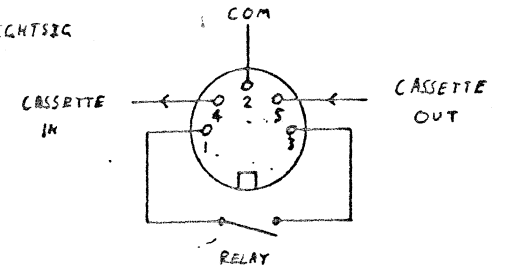

Cassette Connector (DIN)
Looking into socket

Centronics connector
26 way R/A I/O header.
All even pins grounded.
Pin 26 +5V
Pin 23 user Port 7

ITEM	DESCRIPTION	REQ'D	MATERIAL	REMARKS
			SCALE	PASSED
				DATE
	Analog I/O, Cassette interface, Centronics interface, Sound circuitry & Input port.		DRAWN	DRAWING NUMBER
			TRACED	4
			CHECKED	

-5 Pin header only
Reference COM A